

# Three Phase Rectifier Bridge with Brake Chopper

$V_{RRM} = 1200/1600 \text{ V}$   
 $I_{dAVM} = 110 \text{ A}$

**Part name** (Marking on product)

VUB72-12NOXT  
 VUB72-16NOXT

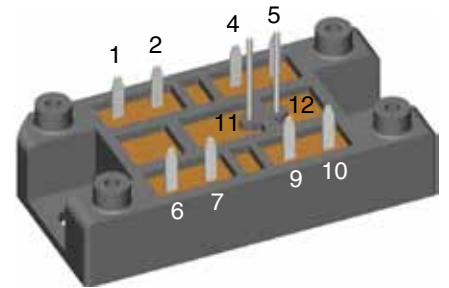
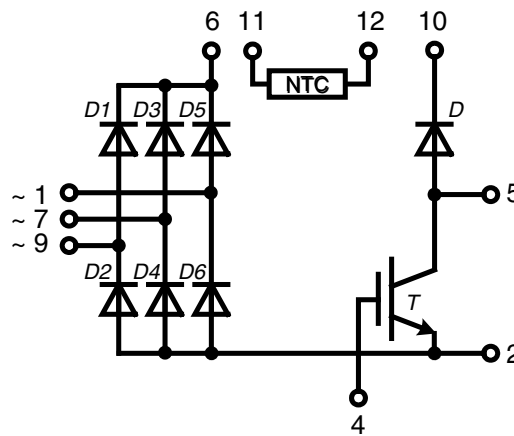

**Features:**

- Three phase mains rectifier
- Brake chopper:
  - IGBT with low saturation voltage
  - HiPerFRED™ free wheeling diode

**Application:**

- Drives with
  - mains input
  - DC link
  - inverter or chopper feeding the machine
  - motor and generator/brake operation

**Package:**

- High level of integration
- Solder terminals for PCB mounting
- UL pending, E72873
- Isolated DCB ceramic base plate
- Large creepage and strike distances
- High reliability

**Chopper IGBT T**

Symbol	Definitions	Conditions	Ratings			Unit
			min.	typ.	max.	
$V_{CES}$	collector emitter voltage	$T_{VJ} = 25^{\circ}\text{C to } 150^{\circ}\text{C}$			1200	V
$V_{GES}$	max. DC gate voltage	continuous	-20		+20	V
$I_{C25}$	collector current	DC			58	A
$I_{C80}$	collector current	DC			40	A
$V_{CE(sat)}$	collector emitter saturation voltage	$I_C = 35\text{ A}; V_{GE} = 15\text{ V}$			1.85 2.15	V
$V_{GE(th)}$	gate emitter threshold voltage	$I_C = 1\text{ mA}$	5.4		6.5	V
$I_{CES}$	collector emitter leakage current	$V_{CE} = V_{CES}; V_{GE} = 0\text{ V}$			0.1	mA mA
$I_{GES}$	gate emitter leakage current	$V_{CE} = 0\text{ V}; V_{GE} = \pm 20\text{ V}$			500	nA
$t_{d(on)}$	turn-on delay time	inductive load $T_{VJ} = 125^{\circ}\text{C}$ $V_{CE} = 600\text{ V}; I_C = 35\text{ A}$ $V_{GE} = \pm 15\text{ V}; R_G = 27\ \Omega; L = 100\ \mu\text{H}$			70	ns
$t_r$	current rise time				40	ns
$t_{d(off)}$	turn-off delay time				250	ns
$t_f$	current fall time				100	ns
$E_{on}$	turn-on energy per pulse				3.8	mJ
$E_{off}$	turn-off energy per pulse				4.1	mJ
$Q_{Gon}$		$V_{CE} = 600\text{ V}; V_{GE} = 15\text{ V}; I_C = 35\text{ A}$			110	nC
$I_{CM}$	reverse bias safe operating area	RBSOA; $V_{GE} = \pm 15\text{ V}; R_G = 27\ \Omega; L = 100\ \mu\text{H}$		70		A
$V_{CEK}$		clamped inductive load; $T_{VJ} = 125^{\circ}\text{C}$		$\leq V_{CES} - L_S \cdot di/dt$		V
$t_{SC}$ (SCSOA)	short circuit safe operating area	$V_{CE} = 900\text{ V}; V_{GE} = \pm 15\text{ V}; R_G = 27\ \Omega; \text{non-repetitive}$			10	$\mu\text{s}$
$R_{thJC}$	thermal resistance junction to case				0.65	K/W
$R_{thCH}$	thermal resistance case to heatsink	with heat transfer paste, see mounting instructions			0.9	K/W

**Chopper Diode D**

Symbol	Definitions	Conditions	Ratings			Unit
			min.	typ.	max.	
$V_{RRM}$	max. repetitive reverse voltage	$T_{VJ} = 150^{\circ}\text{C}$			1200	V
$I_{F25}$	forward current	DC			25	A
$I_{F80}$	forward current				15	A
$V_F$	forward voltage	$I_F = 25\text{ A}$			2.7 2.0	V V
$I_R$	reverse current	$V_R = V_{RRM}$			0.1	mA mA
$I_{RM}$	reverse recovery current	$I_F = 15\text{ A}; V_R = 600\text{ V}$			16	A
$t_{rr}$	reverse recovery time	$di_F/dt = -400\text{ A}/\mu\text{s}$			130	ns
$R_{thJC}$	thermal resistance junction to case				2.3	K/W
$R_{thJH}$	thermal resistance case to heatsink	with heat transfer paste			3.12	K/W

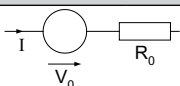
**Equivalent Circuits for Simulation**

Symbol	Definitions	Conditions	Ratings			Unit
			min.	typ.	max.	
$V_0$	Diode	D1 - D6		0.85		V
$R_0$				7		$\text{m}\Omega$
$V_0$	IGBT	T		1.1		V
$R_0$				40		$\text{m}\Omega$
$V_0$	Diode	D		1.25		V
$R_0$				32		$\text{m}\Omega$

IXYS reserves the right to change limits, test conditions and dimensions.

20101119a

**Input Rectifier Diode D1 - D6**

Symbol	Conditions			Ratings			
				min.	typ.	max.	
$V_{RRM}$	<i>max. repetitive reverse voltage</i>	VUB 72 -12 NO1	$T_{VJ} = 25^{\circ}\text{C}$			1200	V
		VUB 72 -16 NO1				1600	V
$I_{FAV}$	<i>average forward current</i>	sine 180°	$T_C = 80^{\circ}\text{C}$			40	A
$I_{D(AV)M}$	<i>max. average DC output current</i>	rectangular; $d = 1/3$ ; bridge	$T_C = 80^{\circ}\text{C}$			110	A
$I_{FSM}$	<i>max. surge forward current</i>	$t = 10\text{ ms}$ ; sine 50 Hz	$T_{VJ} = 25^{\circ}\text{C}$			530	A
$P_{tot}$	<i>total power dissipation</i>		$T_C = 25^{\circ}\text{C}$			100	W
$I_R$	<i>reverse current</i>	$V_R = V_{RRM}$	$T_{VJ} = 25^{\circ}\text{C}$			0.02	mA
		$V_R = 0.8 \cdot V_{RRM}$	$T_{VJ} = 125^{\circ}\text{C}$		0.4		mA
$V_F$	<i>forward voltage</i>	$I_F = 25\text{ A}$	$T_{VJ} = 25^{\circ}\text{C}$		1.0	1.1	V
			$T_{VJ} = 125^{\circ}\text{C}$		0.9		V
$R_{thJC}$	<i>thermal resistance junction to case</i>	per diode	$T_{VJ} = 25^{\circ}\text{C}$			1.2	K/W
$R_{thJH}$	<i>thermal resistance case to heatsink</i>	with heat transfer paste	$T_{VJ} = 25^{\circ}\text{C}$			1.42	K/W

**Temperature Sensor NTC**

Symbol	Definitions	Conditions		Ratings			Unit
				min.	typ.	max.	
$R_{25}$	<i>resistance</i>	$\left\{ R(T) = R_{25} \cdot e^{B_{25/100} \left[ \frac{1}{T} - \frac{1}{298K} \right]} \right\}$	$T = 25^{\circ}\text{C}$		2.2		k $\Omega$
$B_{25/100}$					3560		K

**Module**

Symbol	Definitions	Conditions		Ratings			Unit
				min.	typ.	max.	
$I_{RMS}$	<i>RMS current</i>	per pin				100	A
$T_{VJ}$	<i>operating temperature</i>			-40		150	$^{\circ}\text{C}$
$T_{VJM}$	<i>max. virtual junction temperature</i>					150	$^{\circ}\text{C}$
$T_{stg}$	<i>storage temperature</i>			-40		125	$^{\circ}\text{C}$
$V_{ISOL}$	<i>isolation voltage</i>	$I_{ISOL} \leq 1\text{ mA}$ ; 50/60 Hz;	$t = 1\text{ min}$			3600	V~
$M_d$	<i>mounting torque</i>	(M5)		2		2.5	Nm
$d_S$	<i>creep distance on surface</i>			5			mm
$d_A$	<i>strike distance through air</i>			5			mm
<b>Weight</b>					35		g

**Outline Drawing**

Dimensions in mm (1 mm = 0.0394")

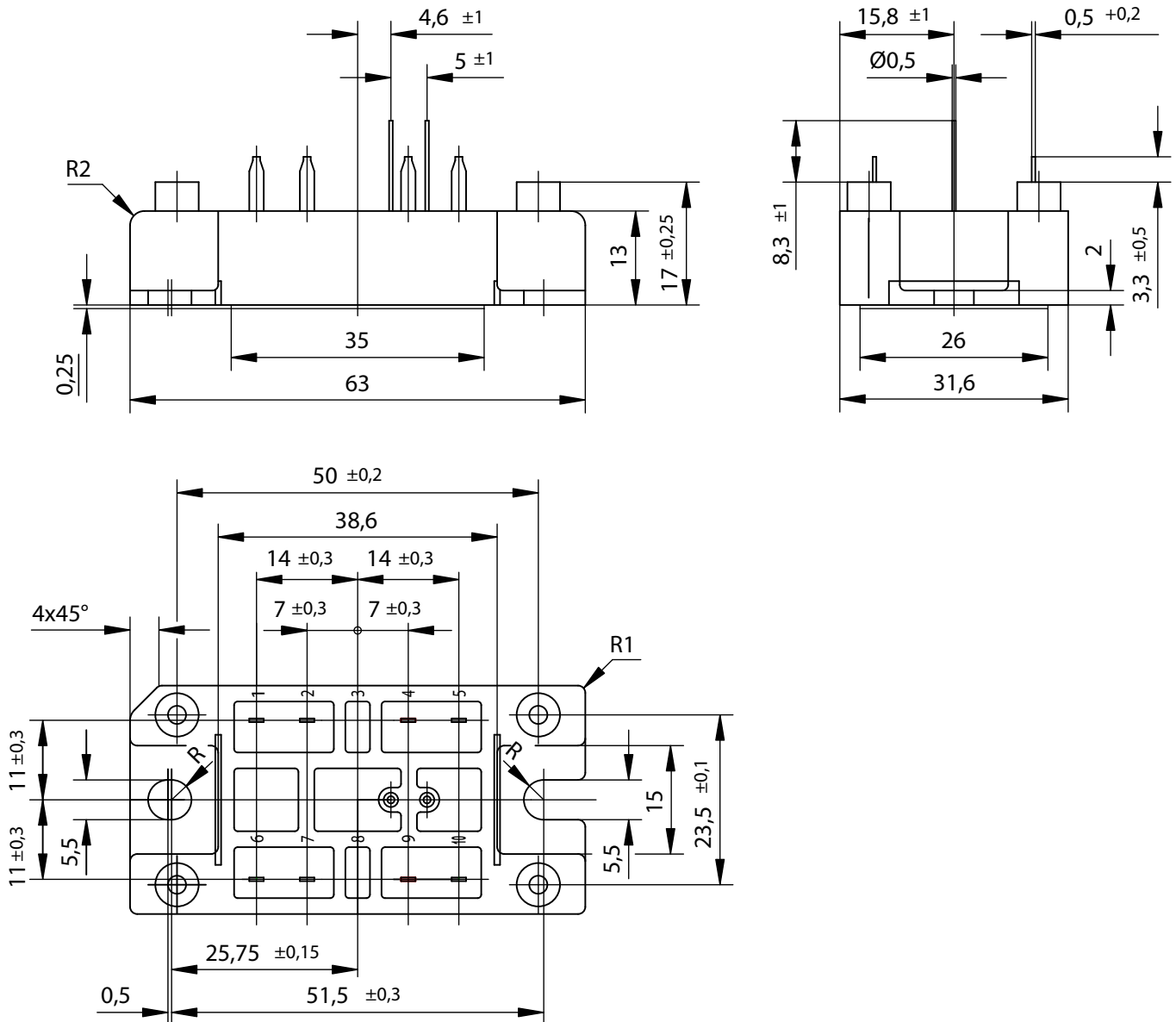
**Product Marking**

Ordering	Part Name	Marking on Product	Delivering Mode	Base Qty	Ordering Code
Standard	VUB 72-12NOXT	VUB72-12NOXT	Box	10	510734
Standard	VUB 72-16NOXT	VUB72-16NOXT	Box	10	510741

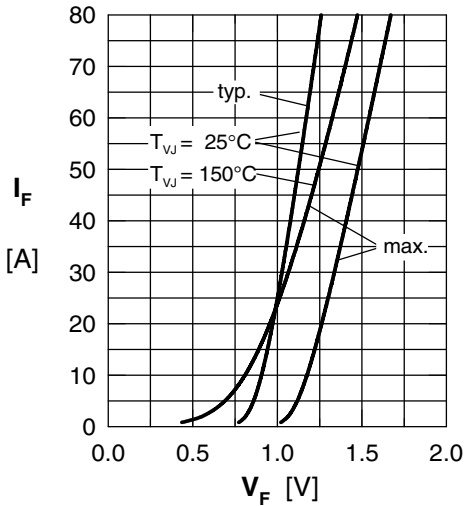

Fig. 1 Forward current vs. voltage drop per rectifier diode

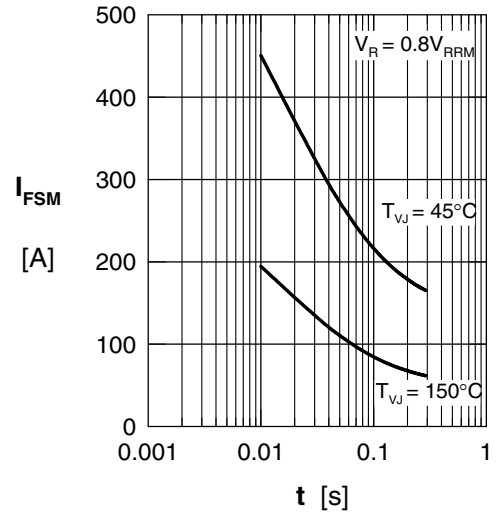

Fig. 2 Surge overload current per rectifier diode

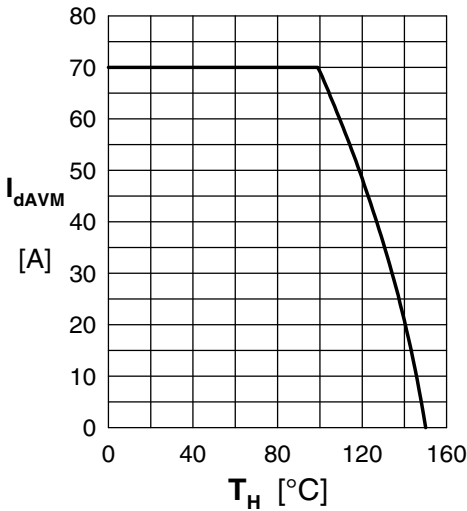

Fig. 3 Max. forward current vs. heatsink temperature (Rectifier bridge)

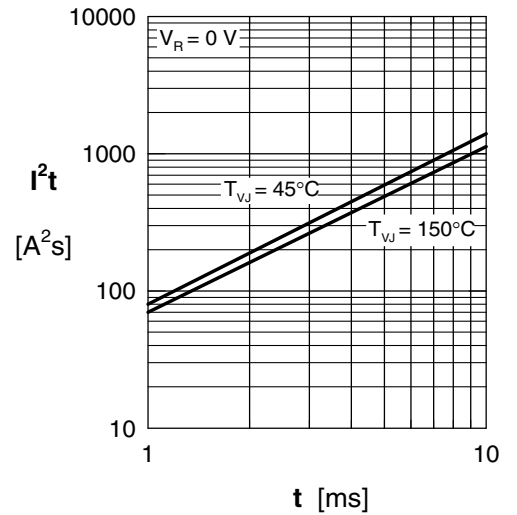

Fig. 4  $I^2t$  versus time per rectifier diode

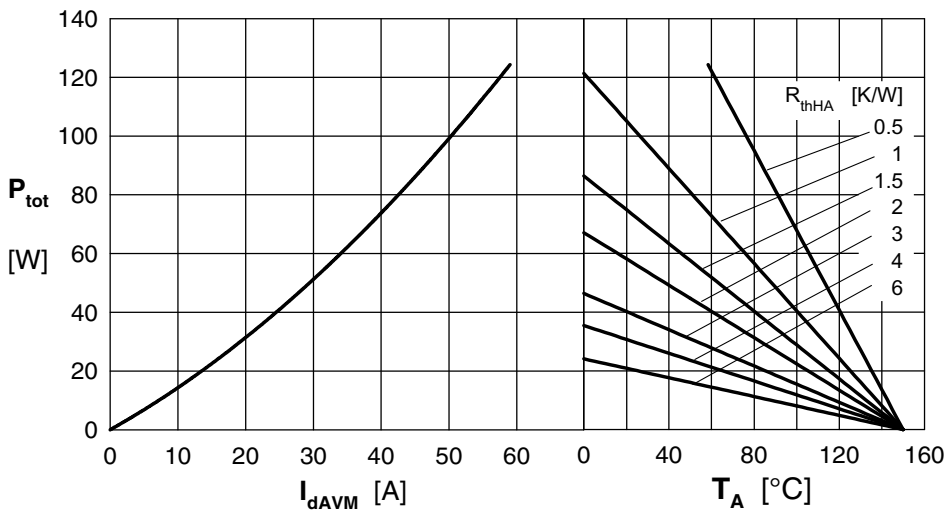

Fig. 5 Power dissipation vs. direct output current & ambient temperature (Rectifier bridge)

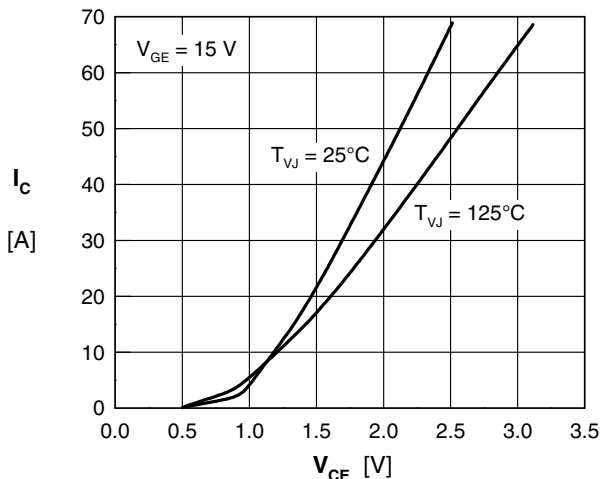

Fig. 6 IGBT, typ. output characteristics

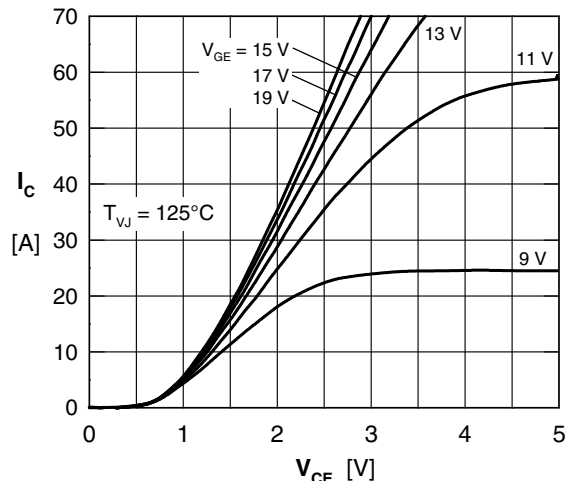

Fig. 7 IGBT, typ. output characteristics

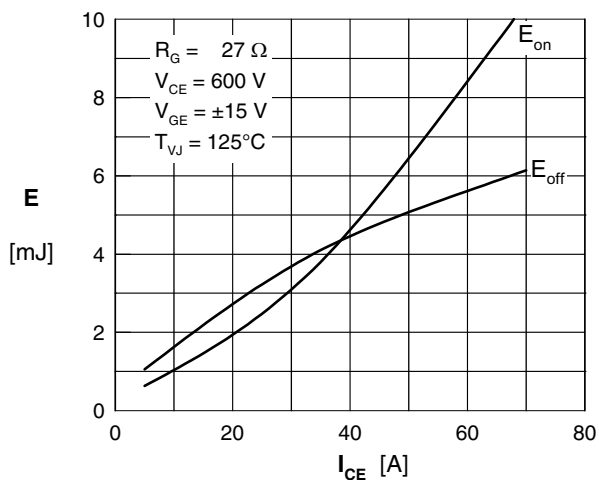

Fig. 8 IGBT, typ. switching energy versus collector current

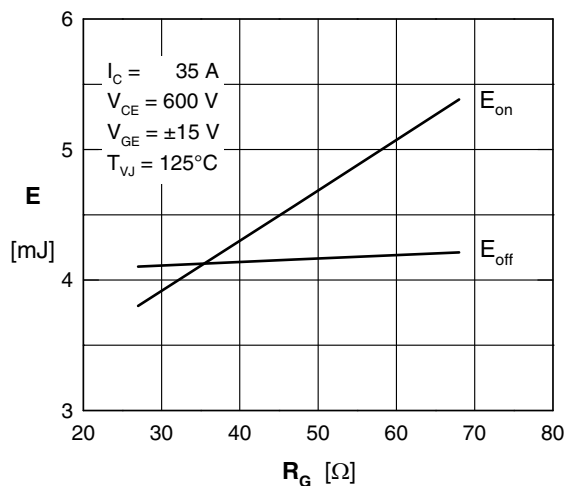

Fig. 9 IGBT, typ. switching energy versus gate resistance

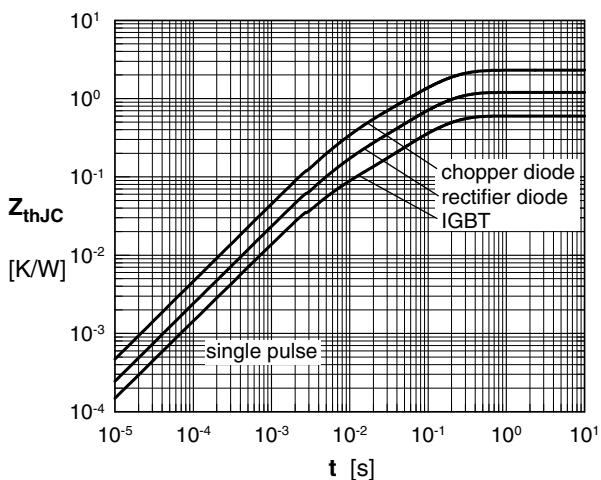

Fig. 10 Typ. transient thermal impedance

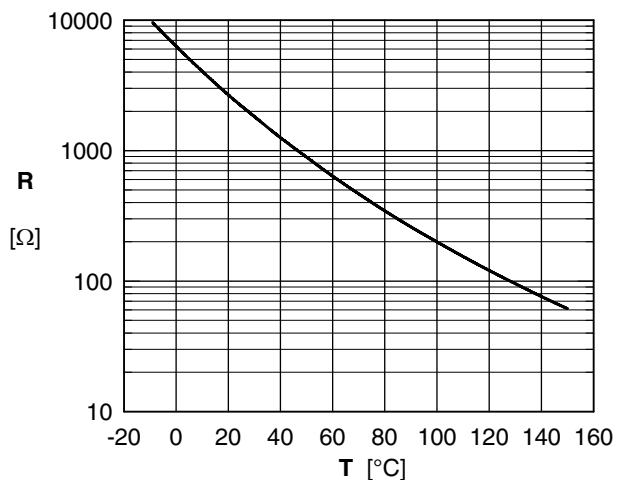

Fig. 11 Typ. thermistor resistance vs. temperature

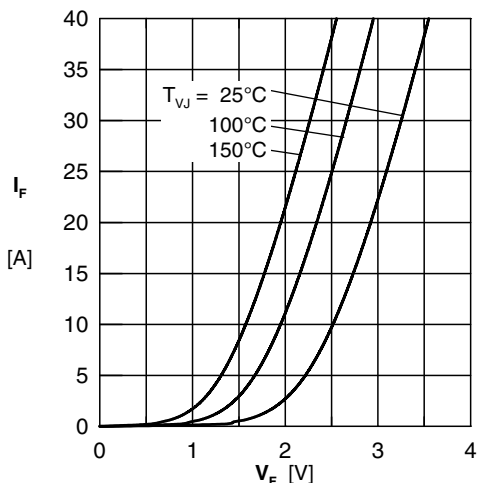

Fig. 12 Forward current  $I_F$  versus  $V_F$

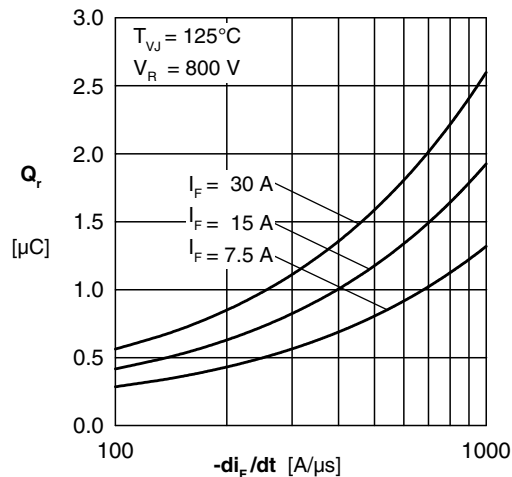

Fig. 13 Typ. reverse recovery charge  $Q_r$  versus  $-di_F/dt$

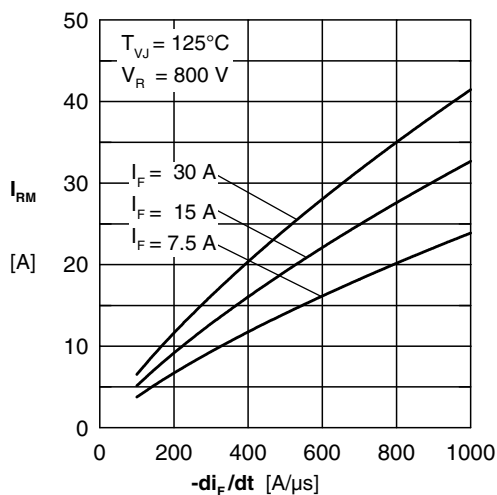

Fig. 14 Typ. peak reverse current  $I_{RM}$  versus  $-di_F/dt$

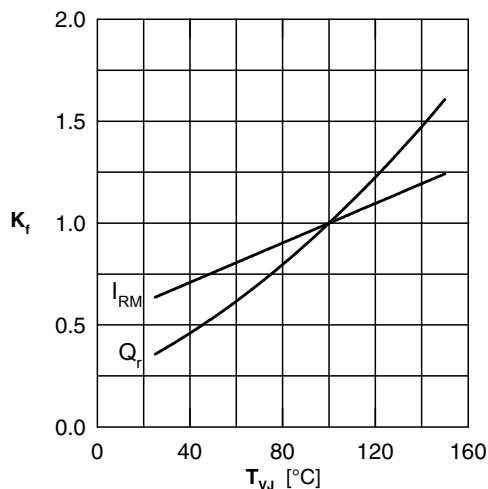

Fig. 15 Dynamic parameters  $Q_r, I_{RM}$  versus  $T_{VJ}$

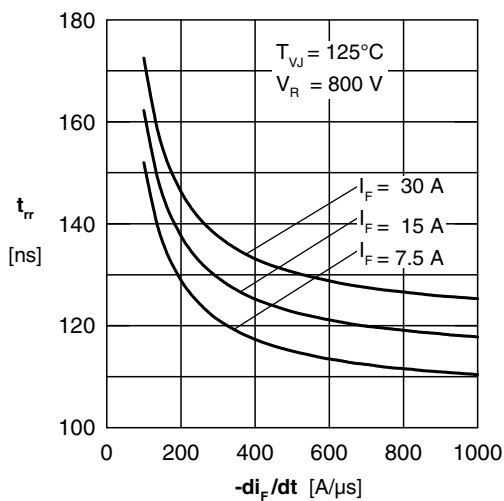

Fig. 16 Typ. recovery time  $t_{tr}$  versus  $-di_F/dt$

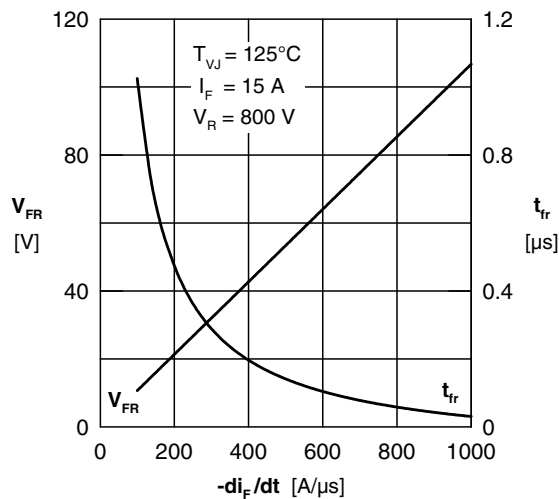

Fig. 17 Typ. peak forward voltage  $V_{FR}$  and  $t_{tr}$  versus  $di_F/dt$